

Linia Praliny VAC

Eine große Auswahl von Saugern für unzählige Anwendungen bei Coniferieprodukten

Line Praline VAC

An abundance of vacuum cups for countless applications of confectionery products.

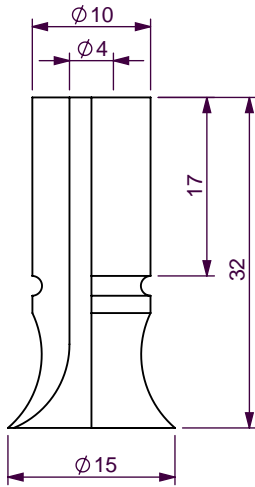

Art. 10.015.114._

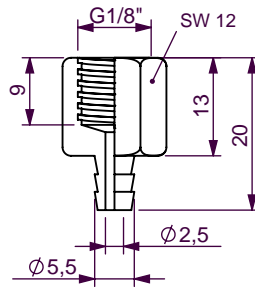

Art. 130.035

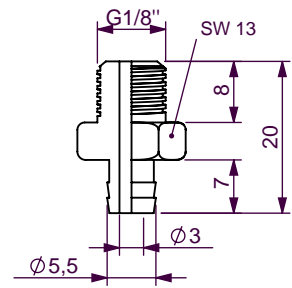

Art. 130.033

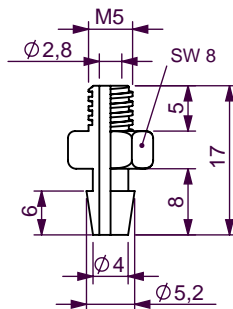

Art. 130.134

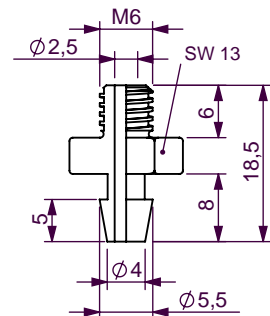

Art. 130.104

Przy zamówieniu dodac wybrany material
When ordering add indicated material

Material NR-Soft (br)

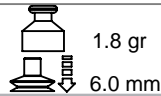

1.8 gr

6.0 mm

Inne materialy na zapytanie
Further materials on request

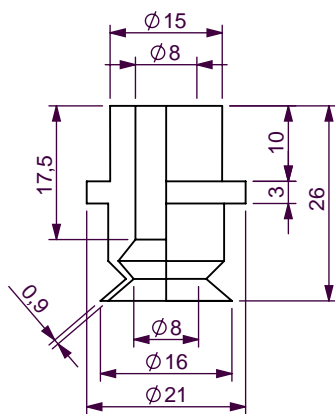

Art. 10.016.091._

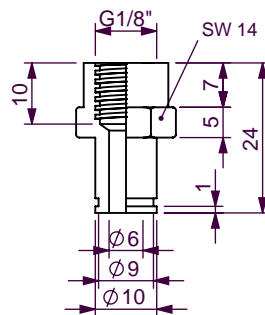

Art. 130.114

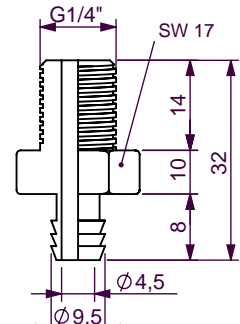

Art. 130.043

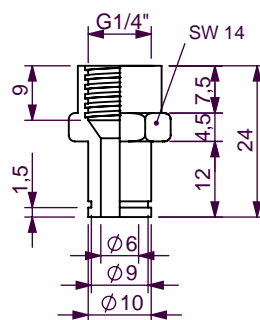

Art. 130.178

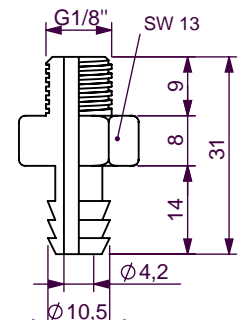

Art. 130.132

Przy zamówieniu dodac wybrany material
When ordering add indicated material

Material S(tr)

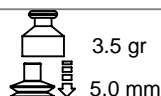

3.5 gr

5.0 mm

Inne materialy na zapytanie
Further materials on request

Reihe Praline VAC

Eine große Auswahl von Saugern für unzählige Anwendungen bei Confiterieprodukten

Line Praline VAC

An abundance of vacuum cups for countless applications of confectionery products.

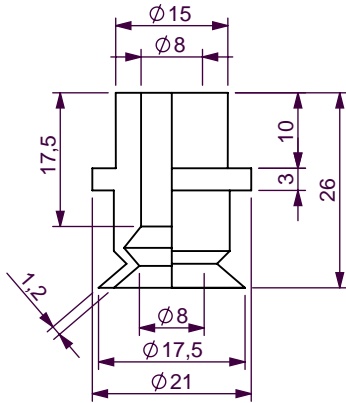

Art. 10.016.092._

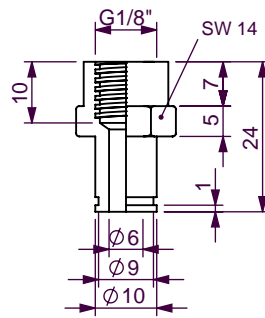

Art. 130.114

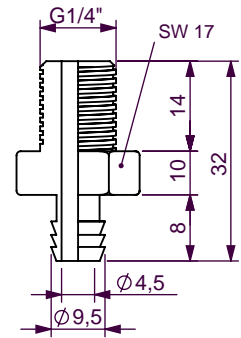

Art. 130.043

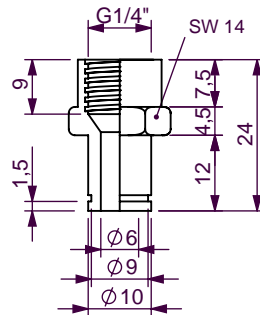

Art. 130.178

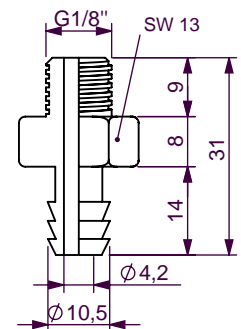

Art. 130.132

Przy zamowieniu dodac wybrany material
When ordering add indicated material

Material S(tr)



3.5 gr

5.0 mm

Inne materialy na zapytanie
Further materials on request

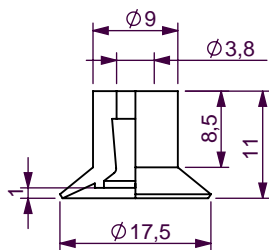

Art. 10.017.255._

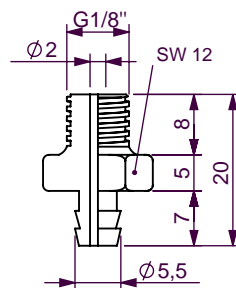

Art. 130.087

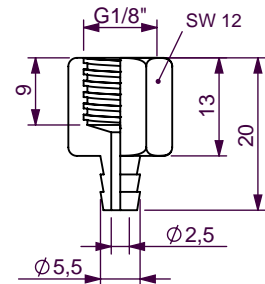

Art. 130.035

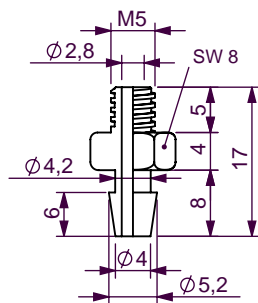

Art. 130.134

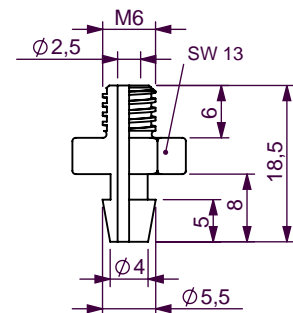

Art. 130.104

Przy zamowieniu dodac wybrany material
When ordering add indicated material

Material NR (sw)



1.0 gr

1.0 mm

Inne materialy na zapytanie
Further materials on request

Reihe Praline VAC

Eine große Auswahl von Saugern für unzählige Anwendungen bei Confiserieprodukten

Line Praline VAC

An abundance of vacuum cups for countless applications of confectionery products.

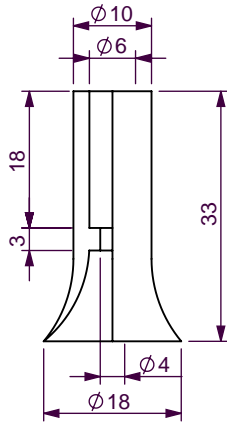

Art. 10.018.088.

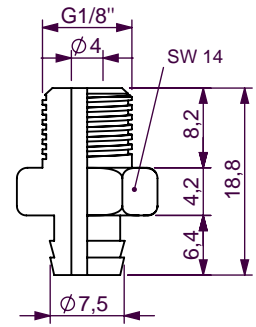

Art. 130.238

Przy zamowieniu dodac wybrany material
When ordering add indicated material

Material S(tr) 50 Shore



1.3 gr

0.0 mm

Inne materialy na zapytanie
Further materials on request

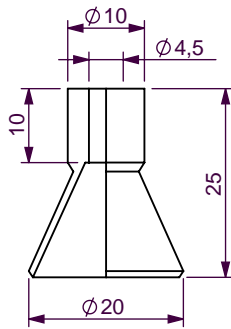

Art. 10.020.297.

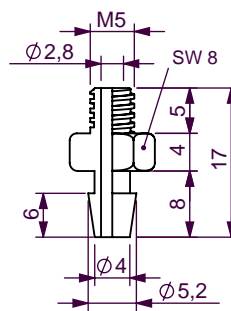

Art. 130.134

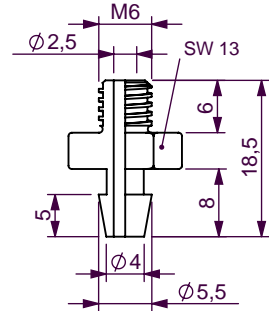

Art. 130.104

Przy zamowieniu dodac wybrany material
When ordering add indicated material

Material NR (sw), S(w)



1.0 gr

0.0 mm

Weitere Materialien auf Anfrage
Further materials on request

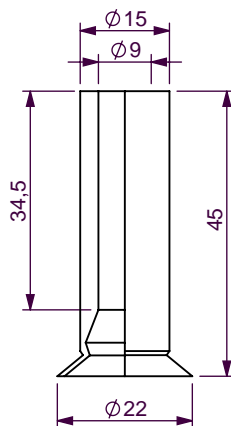

Art. 10.022.308.

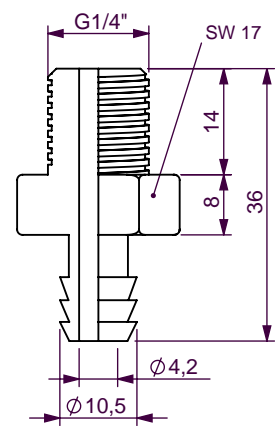

Art. 130.208

Przy zamowieniu dodac wybrany material
When ordering add indicated material

Material NR (sw)



5.2 gr

6.0 mm

Inne materialy na zapytanie
Further materials on request

Reihe Praline VAC

Eine große Auswahl von Saugern für unzählige Anwendungen bei Confiterieprodukten

Line Praline VAC

An abundance of vacuum cups for countless applications of confectionery products.

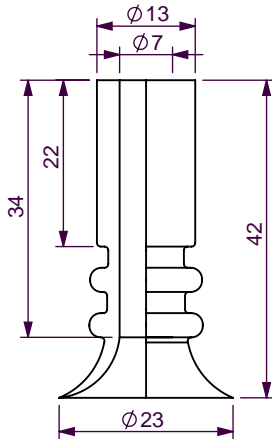

Art. 10.023.612._

Przy zamowieniu dodac wybrany material
When ordering add indicated material

Material S (tr)



5.0 gr

1.5 mm

Inne materialy na zapytanie
Further materials on request

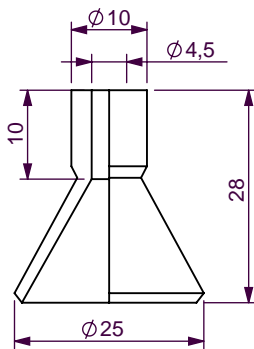

Art. 10.025.361._

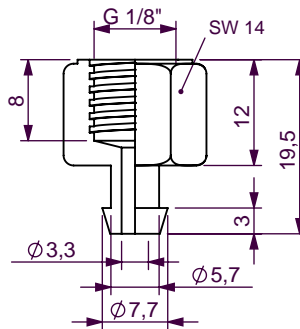

Art. 130.109

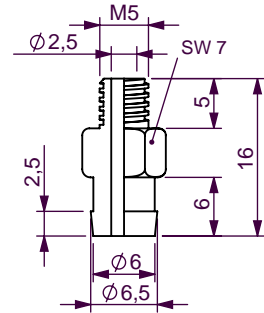

Art. 130.013

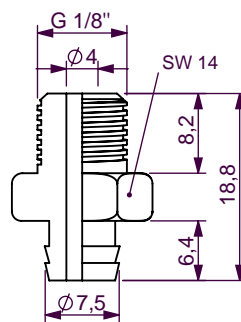

Art. 130.238

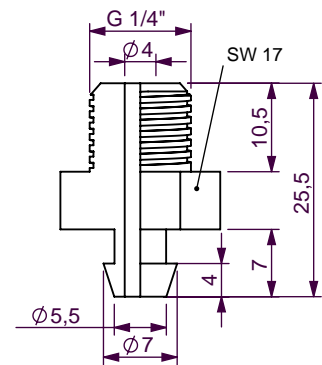

Art. 130.194

Przy zamowieniu dodac wybrany material
When ordering add indicated material

Material NR (sw), **S**(tr)



1.6 gr

0.0 mm

Inne materialy na zapytanie
Further materials on request

Reihe Praline VAC

Eine große Auswahl von Saugern für unzählige Anwendungen bei Confiterieprodukten

Line Praline VAC

An abundance of vacuum cups for countless applications of confectionery products.

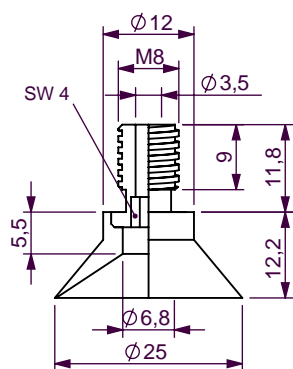

Art. 14.025.037._

Przy zamowieniu dodac wybrany material
When ordering add indicated material

Material S (w)



5.0 gr

5.0 mm

Inne materialy na zapytanie
Further materials on request

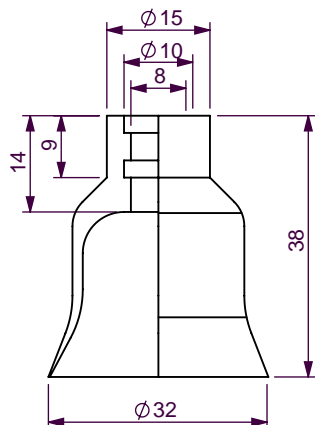

Art. 10.033.578._

Przy zamowieniu dodac wybrany material
When ordering add indicated material

Material S (tr)



6.0 gr

0.0 mm

Inne materialy na zapytanie
Further materials on request

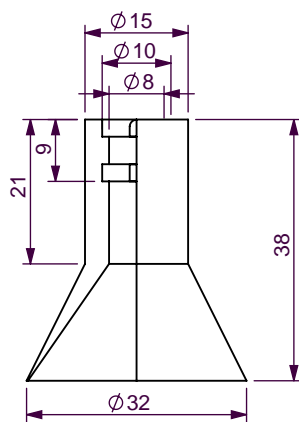

Art. 10.033.579._

Przy zamowieniu dodac wybrany material
When ordering add indicated material

Material S (tr)



7.0 gr

0.0 mm

Inne materialy na zapytanie
Further materials on request

Reihe Praline VAC

Eine große Auswahl von Saugern für unzählige Anwendungen bei Confiterieprodukten

Line Praline VAC

An abundance of vacuum cups for countless applications of confectionery products.

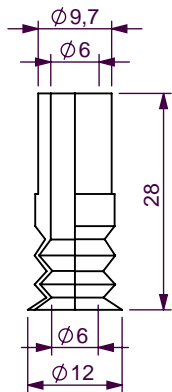

Art. 220.012.024._

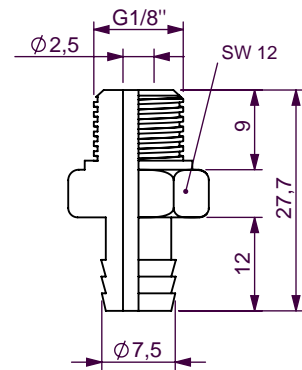

Art. 130.546

Przy zamowieniu dodac wybrany material
When ordering add indicated material

Material S (tr), S-soft (tr), NR-soft (bg)



1.2 gr

6.0 mm

Inne materialy na zapytanie
Further materials on request

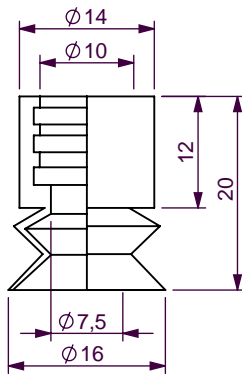

Art. 210.016.063._

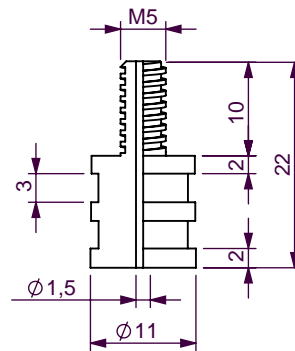

Art. 130.244

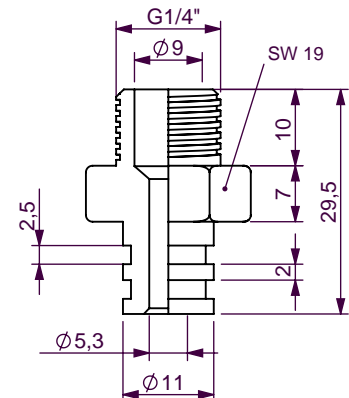

Art. 130.193

Przy zamowieniu dodac wybrany material
When ordering add indicated material

Material S (tr), S (r)



1.6 gr

6.0 mm

Inne materialy na zapytanie
Further materials on request

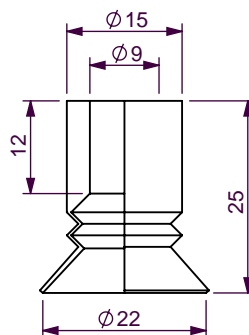

Art. 210.022.142._

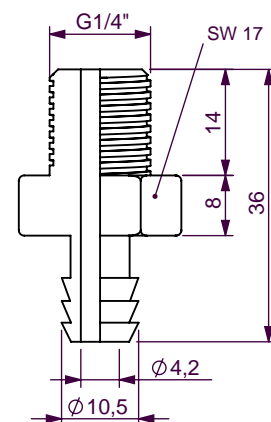

Art. 130.208

Przy zamowieniu dodac wybrany material
When ordering add indicated material

Material S (tr), S-soft (tr), NR (sw)



2.0 gr

8.0 mm

Inne materialy na zapytanie
Further materials on request

Reihe Praline VAC

Eine große Auswahl von Saugern für unzählige Anwendungen bei Coniferieprodukten

Line Praline VAC

An abundance of vacuum cups for countless applications of confectionery products.

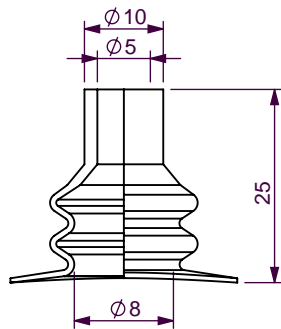
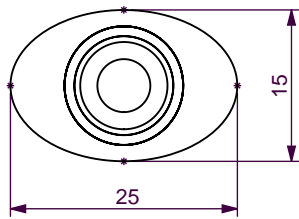

Art. 40.025015.010._

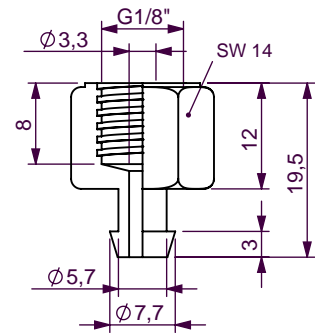

Art. 130.109

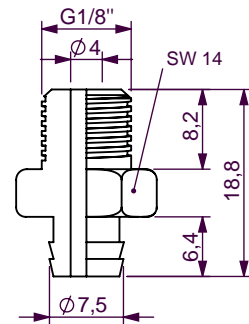

Art. 130.238

Przy zamówieniu dodac wybrany material
When ordering add indicated material

Material S-soft (tr)

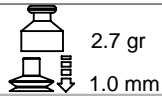

2.7 gr

1.0 mm

Inne materialy na zapytanie
Further materials on request